



VHF MARINE TRANSCEIVER

# IC-M605 EURO

Premium Class D DSC VHF Radio  
with System Flexibility





# Advanced VHF Radio that Complements Your Boat in Superior Performance, System Flexibility and User-Friendliness



## Up to Three COMMAND HEAD/COMMANDMIC™

The IC-M605EURO is our flagship Class D DSC radio. The radio can be remotely controlled with up to three controllers, RC-M600 COMMAND HEAD and/or HM-229B/W COMMANDMIC™, with an intercom function available among the main radio and controllers. Maximum operating flexibility anywhere on your boat.



## Wide Viewing Angle 4.3" Colour TFT LCD

A high resolution colour LCD provides an almost 180 degree very wide viewing angle and displays characters and function icons clearly. The night mode display ensures good readability in the dark for further convenience.



Menu screen



Night mode



## Integrated AIS Receiver

With an integrated AIS receiver, the IC-M605EURO can show real-time AIS vessel traffic information on the display. The AIS combo screen enables you to monitor the AIS plotter during basic operation. You can directly call a selected AIS target from the AIS screen using an individual DSC call.

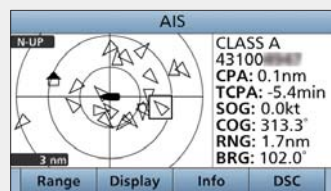

AIS plotter

TARGET LIST (136)			
MMSI/Name	RNG	BRG	
DAIEMARU NO.3	3.3	154	
GYOKO MARU	3.4	147	
MIRAIE	3.4	249	
TOKUYO MARU NO21	3.9	259	
	Display	Info	DSC

Target list



## Intuitive User Interface

The combination of the directional keypad and soft keys provides simple operation. The most common functions are assigned to soft keys (at the bottom of the display) for quick push function access. The large ten-key pad enables you to smoothly enter channel numbers, MMSI numbers with ID names and so on.



## Class Leading Receiver Performance

A weak signal adjacent to a strong signal can be clearly received by the IC-M605EURO. Its commercial grade receiver performance (selectivity and IMD: more than 75 dB) provides reliable communication at all time.



## Active Noise Cancelling Technology

The Active Noise Cancelling technology digitally removes background noise from both transmit and receive audio and provides clear communication in a noisy maritime environment.



## Last Call Voice Recording

The last call voice recording function automatically saves up to two minutes of an incoming call. Don't miss any incoming messages.



## Private Conversation

With an optional voice scrambler unit, UT-112, the IC-M605EURO provides 32 tone secure conversation. This function is useful when you want to share private information with consort ships.



## Provides Clear, Loud Audio

The IC-M605EURO's internal speaker enhances intelligibility of received calls. The waterproof speaker cone provides superior sound quality with a wide frequency range and a flat frequency response for powerful, yet clear audio.



## Integrated GNSS Receiver

The GNSS (GPS, GLONASS and SBAS) receiver is integrated in the IC-M605EURO. Position information can be simply received with connection to the supplied GNSS antenna with 5 m cable, UX-241.



## 30 W Two-Way Hailer and Automatic Foghorn

When connected to the optional SP-37 horn speaker, you can talk with crew on the deck or shore from the radio's microphone and can hear any reply via the horn speaker. Also available the RX hailer function and four patterns of automatic foghorn.



## NMEA 2000™, NMEA 0183/-HS Connectivity

Using NMEA 2000™ connectivity, the radio can exchange GNSS, AIS reports, DSC call information data, radio frequency and PGN list data on the network. NMEA 0183/-HS GNSS position data can also be converted to NMEA 2000™ data for other equipment.

## And more

- IPX8 advanced waterproof (1 m depth of water for 60 minutes)
- Dual and Tri-watch functions • AquaQuake™ draining function
- Instant-access button for Channel 16 and call channel
- Supplied speaker microphone, HM-205RB can be connected to the rear panel
- Compatible with the Icom's marine navigation system, MarineCommander™
- Supports new four-digit channels effective from January 1, 2017

## VHF MARINE TRANSCEIVER

# IC-M605EURO





## SPECIFICATIONS

GENERAL	
Frequency range	Tx* 156.025–161.425 MHz Rx* 156.025–162.000 MHz CH70 156.525 MHz AIS1, 2 161.975, 162.025 MHz * Each frequency range is differ according to versions.
Usable channels	INT, USA* channels * Available depending on version
Type of emission	16K0G3E (FM), 16K0G2B (DSC)
Power supply requirement	13.8 V DC (10.8–15.6 V DC)
Current drain (at 13.8 V DC)	Tx 25 W output 6.0 A Rx Max. audio 8.0 A
Operating temperature range	–20°C to +60°C
Antenna impedance	50 Ω (SO-239)
Weight (approximately)	1510 g; 3.3 lb
TRANSMITTER	
Output power (at 13.8 V DC)	25 W, 1 W
Max. frequency deviation	±5.0 kHz
Frequency stability	Less than ±0.5 kHz
Spurious emissions	Less than 0.25 µW
Residual modulation	More than 40 dB
Adjacent channel power	More than 70 dB
RECEIVER	
Intermediate frequency	30.15 MHz, 450 kHz (1st/2nd) CH70 21.70 MHz, 450 kHz (1st/2nd)
Sensitivity	CH70 –5 dBµ emf typ. (20 dB SINAD) –3 dBµ emf typ. (1% BER)
Adjacent channel selectivity	CH70 (1% BER) More than 75 dB More than 80 dBµ emf
Spurious response	CH70 (1% BER) More than 75 dB More than 73 dBµ emf
Intermodulation	CH70 (1% BER) More than 75 dB More than 73 dBµ emf
Hum and noise	More than 40 dB
Audio output power (at 10% distortion)	More than 15 W with a 4 Ω external speaker

Measurements made in accordance with EN301 025-2, -3. All stated specifications are subject to change without notice or obligation.

### Applicable U.S. Military Specifications

Standard	MIL 810 G	
	Method	Procedure
Low Pressure	500.5	I, II
High Temperature	501.5	I, II
Low Temperature	502.5	I, II
Temperature Shock	503.5	I-C
Solar Radiation	505.5	I
Rain	506.5	I
Humidity	507.5	II
Salt Fog	509.5	-
Dust Blowing	510.5	I
Immersion	512.5	I
Vibration	514.6	I
Shock	516.6	I, IV

Also meets equivalent MIL-STD-810-C, -D, -E and -F.

### Applicable IP Rating

Ingress Protection Standard	
Water	IPX8 (1 m depth water for 60 minutes)

### Supplied accessories:





- Speaker microphone, HM-205RB
- GNSS antenna, UX-241
- Microphone hanger
- DC power cable
- Mounting bracket kit

## OPTIONS

Some options may not be available in some countries. Please ask your dealer for details.

<b>COMMANDMIC™</b>  <b>HM-229B</b> (Black)* <b>HM-229W</b> (White)*	<b>Supplied accessories</b>  <ul style="list-style-type: none"> <li>• OPC-1540. 6.1 m (20 ft) cable</li> <li>• Microphone hanger</li> <li>• Mounting base for connector</li> </ul> * Optional OPC-2384 is required.	<b>CONVERSION CABLE</b>  <b>OPC-2384</b> 12-pin to 8-pin. Required for COMMANDMIC.	<b>EXTENSION CABLE</b>  <b>OPC-1541</b> 6.1 m (20 ft). Up to two cables available.
---	---	--	---

<b>COMMAND HEAD</b>  <b>RC-M600</b> IPX8 advanced waterproof (1 m depth of water for 60 min.).	<b>Supplied accessories</b>  <ul style="list-style-type: none"> <li>• OPC-2383, 10 m (32.8 ft) cable</li> <li>• Speaker microphone, HM-205RB</li> <li>• DC power cable</li> <li>• MIC hanger</li> <li>• Mobile bracket kit</li> </ul>	<b>EXTENSION CABLE</b>  <b>OPC-2377</b> 10 m (32.8 ft). Up to four cables available.
--	--	---

<b>HORN SPEAKER</b>  <b>SP-37</b>	<b>VOICE SCRAMBLER UNIT</b>  <b>UT-112</b>	<b>FLUSH MOUNT KIT</b>  <b>MB-75</b>	<b>SPEAKER-MICROPHONE</b>  <b>HM-205RB</b> Same as supplied.	<b>GNSS ANTENNA</b>  <b>UX-241</b> Same as supplied.
--	---	---	--	--

<b>CLASS B AIS TRANSPONDER</b>  <b>MA-500TR</b> For transmitting own vessel AIS information.	<b>CABLES for COMMAND HEAD/COMMANDMIC™</b> <table border="1"> <thead> <tr> <th></th> <th>For connection</th> <th>For extension</th> </tr> </thead> <tbody> <tr> <td>RC-M600</td> <td>OPC-2383</td> <td>OPC-2377* (up to four cables available)</td> </tr> <tr> <td>HM-229B/W</td> <td>OPC-2384*, OPC-1540</td> <td>OPC-1541* (up to two cables available)</td> </tr> </tbody> </table> * Options.		For connection	For extension	RC-M600	OPC-2383	OPC-2377* (up to four cables available)	HM-229B/W	OPC-2384*, OPC-1540	OPC-1541* (up to two cables available)
	For connection	For extension								
RC-M600	OPC-2383	OPC-2377* (up to four cables available)								
HM-229B/W	OPC-2384*, OPC-1540	OPC-1541* (up to two cables available)								

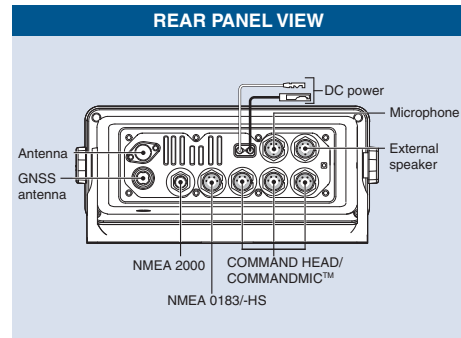
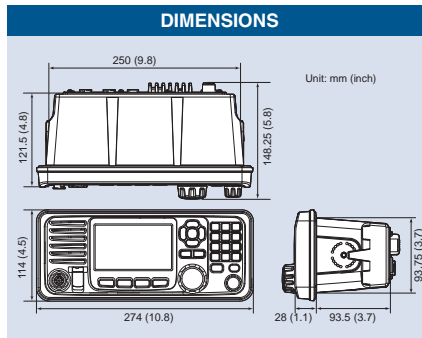

Icom, Icom Inc. and the Icom logo are registered trademarks of Icom Incorporated (Japan) in Japan, the United States, the United Kingdom, Germany, France, Spain, Russia, Australia, New Zealand and/or other countries. COMMANDMIC, AquaQuake and MarineCommander are trademarks of Icom Inc. (Japan) in the United States. NMEA 2000 is a trademark of the National Maritime Electronics Association, Inc. All other trademarks are the properties of their respective holders.

**Icom Inc.** 1-1-32, Kami-minami, Hirano-Ku, Osaka 547-0003, Japan Phone: +81 (06) 6793 5302 Fax: +81 (06) 6793 0013 [www.icom.co.jp/world](http://www.icom.co.jp/world) **Count on us!**

**Icom America Inc.**  
 12421 Willows Road NE,  
 Kirkland, WA 98034, U.S.A.  
 Phone: +1 (425) 454-8155  
 Fax: +1 (425) 454-1509  
 E-mail: sales@icomamerica.com  
 URL: <http://www.icomamerica.com>

**Icom (Europe) GmbH**  
 Communication Equipment  
 Auf der Krautweide 24  
 65812 Bad Soden am Taunus, Germany  
 Phone: +49 (6196) 76685-0  
 Fax: +49 (6196) 76685-50  
 E-mail: info@icomeurope.com  
 URL: <http://www.icomeurope.com>

**Icom France s.a.s.**  
 Zac de la Plaine,  
 1 Rue Brindejonc des Moulinais, BP 45804,  
 31505 Toulouse Cedex 5, France  
 Phone: +33 (5) 61 36 03 03  
 Fax: +33 (5) 61 36 03 00  
 E-mail: icom@icom-france.com  
 URL: <http://www.icom-france.com>

**Asia Icom Inc.**  
 Unit 1 Cheng-Teh Roa  
 Taipei, Taiwan, R.O.C.  
 Phone: +886 (02) 2559 1899  
 Fax: +886 (02) 2559 1874  
 E-mail: sales@asia-icom.com  
 URL: <http://www.asia-icom.com>



**Icom Canada**  
 Glenwood Centre #150-6165  
 Highway 17A, Delta, B.C.,  
 V4K 5B8, Canada  
 Phone: +1 (604) 952-4266  
 Fax: +1 (604) 952-0090  
 E-mail: info@icomcanada.com  
 URL: <http://www.icomcanada.com>

**Icom Spain S.L.**  
 Ctra. Rubi, No. 88 "Edificio Can Castanyer"  
 Bajos A 08174, Sant Cugat del Valles,  
 Barcelona, Spain  
 Phone: +34 (93) 590 26 70  
 Fax: +34 (93) 589 04 46  
 E-mail: icom@icomspain.com  
 URL: <http://www.icomspain.com>

**Icom (Australia) Pty. Ltd.**  
 Unit 1 / 103 Garden Road,  
 Clayton, VIC 3168 Australia  
 Phone: +61 (03) 9549 7500  
 Fax: +61 (03) 9549 7505  
 E-mail: sales@icom.net.au  
 URL: <http://www.icom.net.au>

**C/La Paz nº35 Bajo  
 33209 Gijón Asturias Spain  
 Tel. 985 171283**

**Icom Brazil**  
 Rua Itororó, 444 Padre Eustáquio  
 Belo Horizonte MG,  
 CEP: 30720-450, Brazil  
 Phone: +55 (31) 3582 8847  
 Fax: +55 (31) 3582 8987  
 E-mail: sales@icombrasil.com

**Icom (UK) Ltd.**  
 Blacksole House, Altira Park,  
 Herne Bay, Kent, CT6 6GZ, U.K.  
 Phone: +44 (0) 1227 741741  
 Fax: +44 (0) 1227 741742  
 E-mail: info@icomuk.co.uk  
 URL: <http://www.icomuk.co.uk>

**Icom New Zealand**  
 39C Rennie Drive, Airport Oaks,  
 Auckland, New Zealand  
 Phone: +64 (09) 274 4062  
 Fax: +64 (09) 274 4708  
 E-mail: inquiries@icom.co.nz  
 URL: <http://www.icom.co.nz>

**swan@swan.es  
 www.swan.es  
 www.walkiesprofesionales.es**